

INDEX

	page
- General	O1
- Dimensions	O2
- Grille selection	O3
- Performances	O4 ÷ O15
- Ordering guidelines / technical description	O16

GENERAL FEATURES

Air terminal devices of group O are air grilles (diffusers) mounted on ceilings with fixed blades.

They are manufactured in four main types :

- O1: air discharge towards one direction
- O2: air discharge towards two directions
- O3: air discharge towards three directions
- O4: air discharge towards four directions

Air grilles of series O are used for air supply in low-height rooms of up to 3,5 m height. They may also be used for return air applications. Their blades are fixed. They may be equipped with volume flow regulating dampers of D series, and/or air flow aligner. They can also be manufactured with removable blade frame facilitating internal duct inspection. This construction helps mounting using inner screws (see diagrams on p. O2). They are manufactured at any size, however their usual dimensions are shown in the table of p. O2.

Anodized aluminum profile of 12 µm anodic depth is used for their construction providing long life. Alternatively, electrostatic painting in a variety of colors is available.

Ceiling grilles of O series are manufactured in 4 different types, with 1 to 4 jet directions. Their general configuration is shown in the next figure.

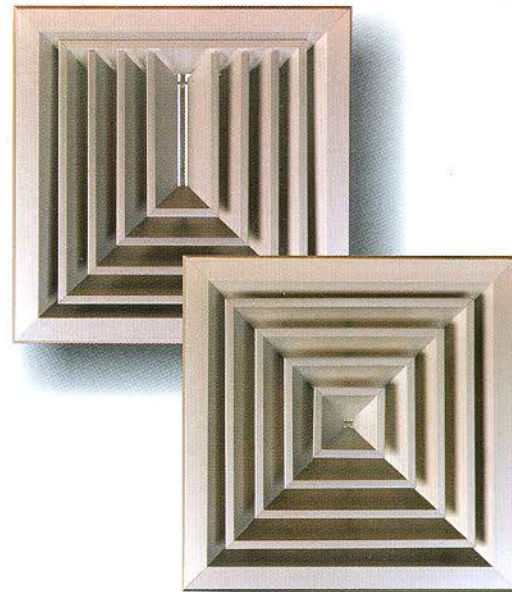

- SERIES O - TYPES

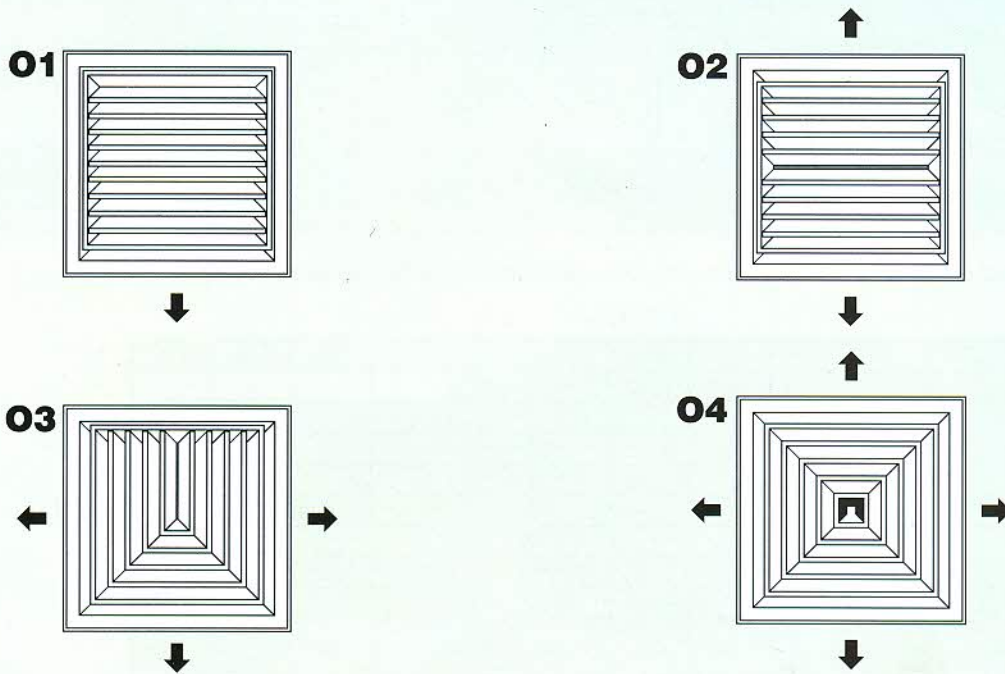

Shape of the air jet

Possible air jet configurations using O series grilles are shown in the adjacent figure. The blades of the grilles are fixed, not allowing adjustment of the flow direction.

The air jet upon meeting an obstacle (e.g. wall), or another air jet, forms a downflow air stream - see figure - having lost most of its momentum. For this reason, series O grilles are not considered appropriate for heating applications in rooms with height more than 3,5 m. They are ideal for low-height rooms up to 3,5m since they provide indirect heating or cooling by means of air recirculation.

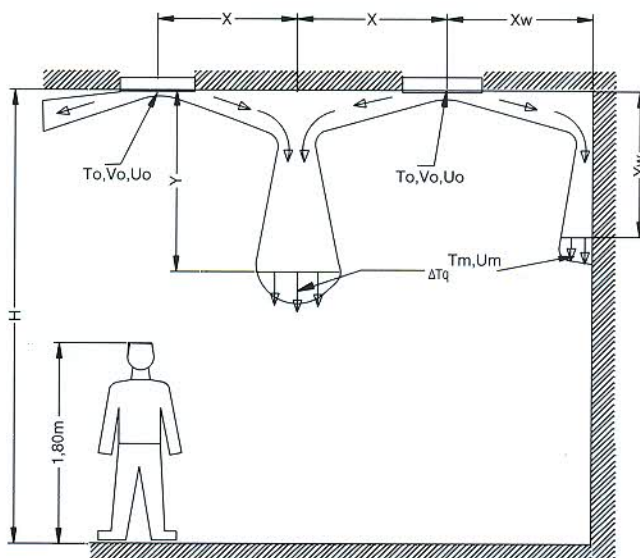

Selection of series O grilles

While selecting grilles of O series it is important that the air jet conditions at distance Y from the ceiling are within specifications (e.g. CEN-CR-1752).

For the selection of O series ceiling grilles the diagrams of pages O4 ÷ O15 are used. The grilles' selection is based on their equivalent diameter. The equivalent diameter can be found for each grille type from the corresponding tables. For grille types of more than one discharge directions the air volume flow to each direction is not the same and can be estimated using the relevant tables.

The selection diagrams provide data for the following parameters:

- Throw of the air jet
- Air velocity along the jet centerline
- Air velocity along the jet centerline for downflow jets resulting either from two impinging jets or from a jet impinging on the wall.
- Pressure drop
- Mean air velocity at the grille
- Noise
- Temperature at the jet centerline

For return air applications using O series grilles the diagrams of pages O4 ÷ O15 may be used for the estimation of the required pressure drop. The resulting noise should be reduced by 7,5 dBA.

The recommended noise levels to be used for grille selection are the following :

Sound rooms, libraries, studios	under 30dBA
Offices, homes, hospital rooms, churches, hotel rooms, theaters	25 to 35dBA
Public buildings, restaurants, public places, banks	30 to 40dBA
Factories, gyms, shops, etc.	35 to 50dBA

The values are indicative and may not represent every case.

Nomenclature

Vo [m³/h]: Air volume flow

Um [m/s]: Air jet centerline velocity at distance Y or Ym from the ceiling

Uo [m/s]: Air velocity at the grille

D_{eq} [m]: Grille equivalent diameter

X, Xw [m]: Half of the horizontal distance between grilles, or horizontal distance between the grille and the wall, respectively

Y, Yw [m]: Vertical distance from the ceiling for impinging air jets or jet impinging to a wall, respectively

H [m]: Room height

ΔP [Pa]: Pressure drop

N [dBA]: Noise level

ΔT_q: Temperature difference ratio $\Delta T_q = (T_m - T_r)/(T_o - T_r)$

To [°C]: Air inlet temperature

Tm [°C]: Air jet temperature at distance Y or Ym from the ceiling

Tr [°C]: Return air temperature

B [m]: Air throw (distance from the grille where the air jet has a velocity of 0,5 m/s)

Selection example

For a space to be properly ventilated 5000 m³/h of air are required. The space hosts offices and the acceptable noise level is 35 dBA. What is the appropriate size of type O1 grilles to cover the previous need?

From the noise level diagram one may find that by using five identical O1 grilles with 1000 m³/h air volume flow each, the equivalent diameter of the grilles should be 0,53 m. Thus, from the next table it is obvious that one may select grilles of dimensions 38X60 or 45X53

The operation data for these grilles are :
 Pressure drop Δp around 17 Pa,
 Air velocity at the grille U_0 around 3,5 m/s,
 Air throw B of around 8,2 m (free jet adjacent to the ceiling).

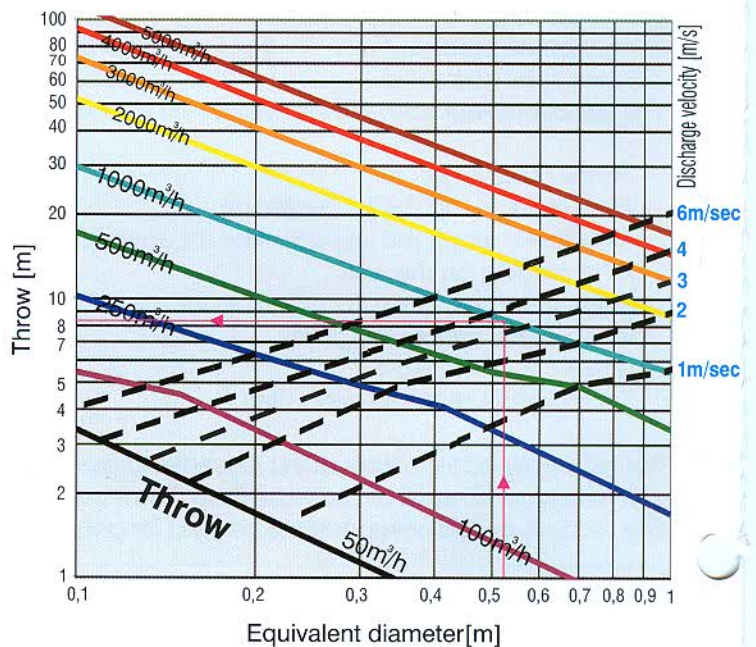
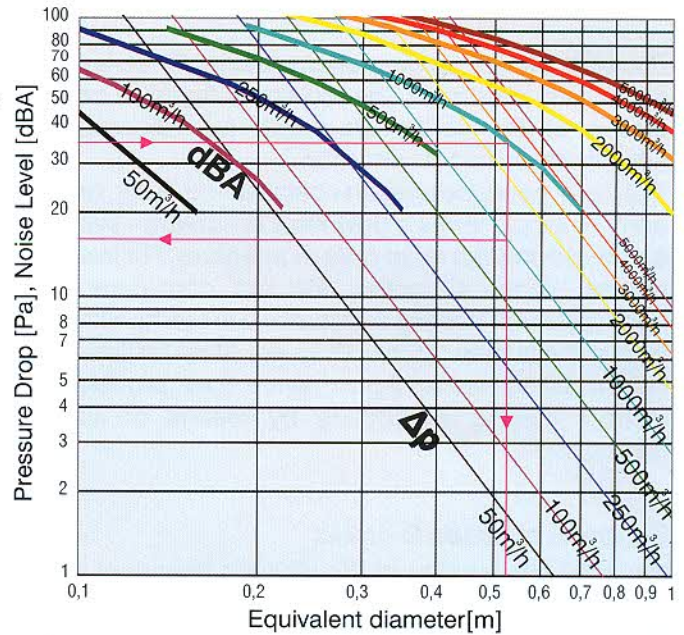

TABLE O1 : EQUIVALENT DIAMETER OF O1 GRILLES (in cm) QUICK SELECTION

		H[cm]											
		15	23	30	38	45	53	60	70	80	90	100	110
W[cm]	15	17	21	24	27	29	32	34	37				
	23	21	26	30	33	36	39	42	45	48	51		
	30	24	30	34	38	41	45	48	52	55	59	62	65
	38	27	33	38	43	47	51	54	58	62	66	70	73
	45	29	36	41	47	51	55	59	63	68	72	76	79
	53	32	39	45	51	55	60	64	69	73	78	82	86
	60	34	42	48	54	59	64	68	73	78	83	87	92
	70	37	45	52	58	63	69	73	79	84	90	94	99
	80		48	55	62	68	73	78	84	90	96	101	106
	90		51	59	66	72	78	83	90	96	102	107	112
100			62	70	76	82	87	94	101	107	113	118	
110			65	73	79	86	92	99	106	112	118	124	

Due to continuous development of its products, AERGRAMMI reserves the right of modifications without prior notice.

Selection example

For a space to be properly ventilated 5000 m³/h of air are required. The space hosts offices and the acceptable noise level is 35 dBA. What is the appropriate size of type O2 grilles to cover the previous need?

From the noise level diagram one may find that by using ten identical O2 grilles with 500 m³/h air flow each, the equivalent diameter of the grilles should be 0,38 m. Thus, from the next table one may select grilles of dimensions 38X30 or 45X23, having an equivalent diameter of 0,36 very close to the one required.

The operation data for these grilles are :
 Pressure drop Δp around 26 Pa,
 Air velocity at the grille U_0 around 3,3 m/s,
 Air throw B of around 5 m (free jet adjacent to the ceiling).

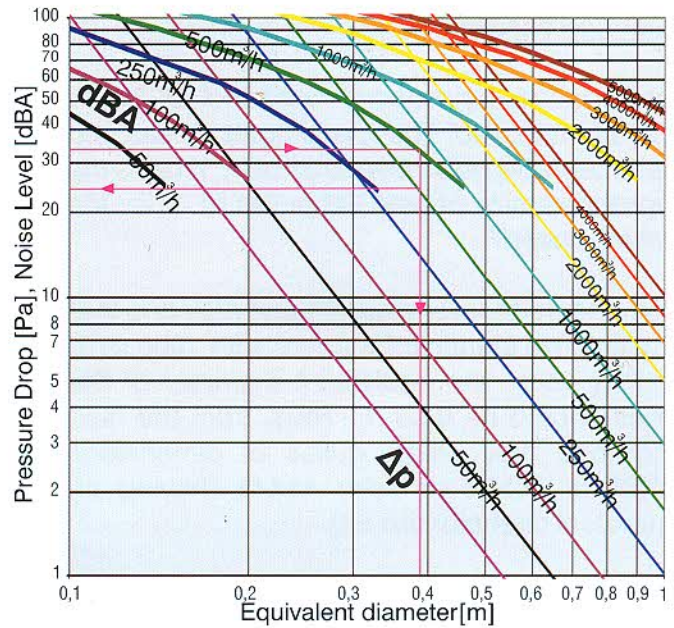

TABLE O2 : EQUIVALENT DIAMETER OF O2 GRILLES (in cm) QUICK SELECTION
 H[cm]

	15	23	30	38	45	53	60	70	80	90	100	110
15	17	21	24	27	29	32	34	37				
23	21	26	30	33	36	39	42	45	48	51		
30	24	30	34	38	41	45	48	52	55	59	62	65
38	27	33	38	43	47	51	54	58	62	66	70	73
45	29	36	41	47	51	55	59	63	68	72	76	79
53	32	39	45	51	55	60	64	69	73	78	82	86
60	34	42	48	54	59	64	68	73	78	83	87	92
70	37	45	52	58	63	69	73	79	84	90	94	99
80		48	55	62	68	73	78	84	90	96	101	106
90		51	59	66	72	78	83	90	96	102	107	112
100			62	70	76	82	87	94	101	107	113	118
110			65	73	79	86	92	99	106	112	118	124

Due to continuous development of its products, AEROGRAMMI reserves the right of modifications without prior notice.

Selection example

For a space to be properly ventilated 5000 m³/h of air are required. The space hosts offices and the acceptable noise level is 35 dBA. What is the appropriate size of type O3 grilles to cover the previous need?

From the noise level diagram one may find that by using five identical O3 grilles with 1000 m³/h air flow each, the equivalent diameter of the grilles should be 0,53 m. Thus, from the next table one may select grilles of dimensions 38X60 or 45X53 or even 45X45 (having an equivalent diameter of 0,51).

The operation data for these grilles are :
 Pressure drop Δp around 12 Pa,
 Air velocity U_0 at the grille around 4 m/s,
 Air throw B of around 6 m (free jet adjacent to the ceiling).

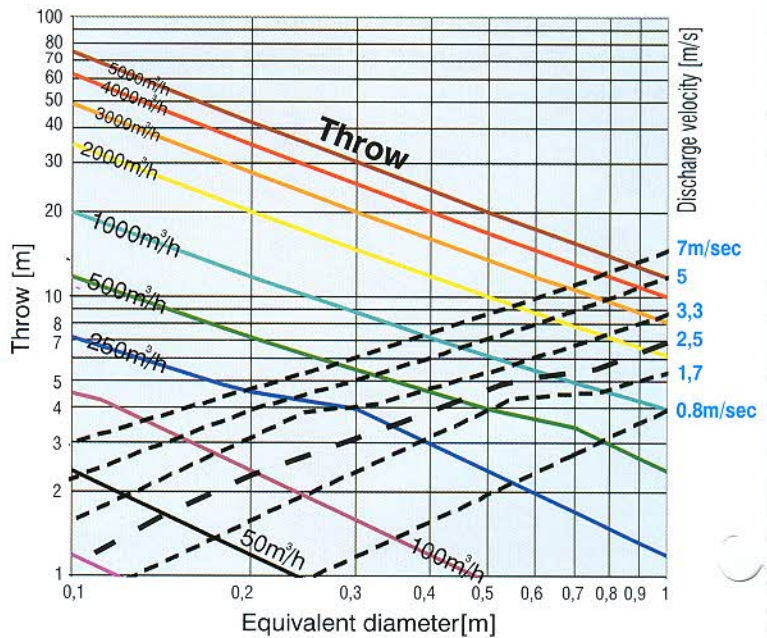
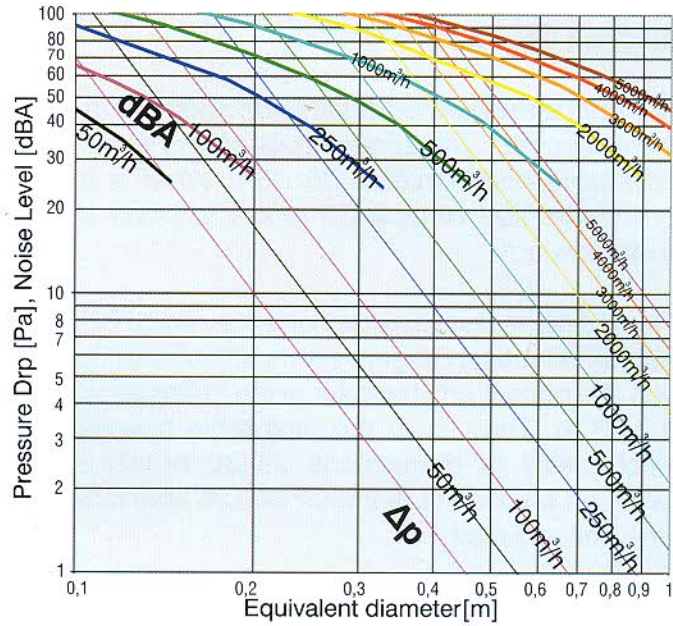

TABLE O3 : EQUIVALENT DIAMETER OF O3 GRILLES (in cm) QUICK SELECTION

	H[cm]											
	15	23	30	38	45	53	60	70	80	90	100	110
15	17	21	24	27	29	32	34	37				
23	21	26	30	33	36	39	42	45	48	51		
30	24	30	34	38	41	45	48	52	55	59	62	65
38	27	33	38	43	47	51	54	58	62	66	70	73
45	29	36	41	47	51	55	59	63	68	72	76	79
53	32	39	45	51	55	60	64	69	73	78	82	86
60	34	42	48	54	59	64	68	73	78	83	87	92
70	37	45	52	58	63	69	73	79	84	90	94	99
80		48	55	62	68	73	78	84	90	96	101	106
90		51	59	66	72	78	83	90	96	102	107	112
100			62	70	76	82	87	94	101	107	113	118
110			65	73	79	86	92	99	106	112	118	124

Due to continuous development of its products, AERGRAMMI reserves the right of modifications without prior notice.

Selection example

For a space to be properly ventilated 5000 m³/h of air are required. The space hosts offices and the acceptable noise level is 35 dBA. What is the appropriate size of type O4 grilles to cover the previous need?

From the noise level diagram one may find that by using ten identical O4 grilles with 500 m³/h air flow each, the equivalent diameter of the grilles should be 0,38 m. Thus, from the next table one may select grilles of dimensions 38X30 or 45X23, or even 23X53.

The operation data for these grilles are :

- Pressure drop Δp around 16 Pa,
- Air velocity U_0 at the grille around 3,3 m/s,
- Air throw B of around 4 m (free jet adjacent to the ceiling).

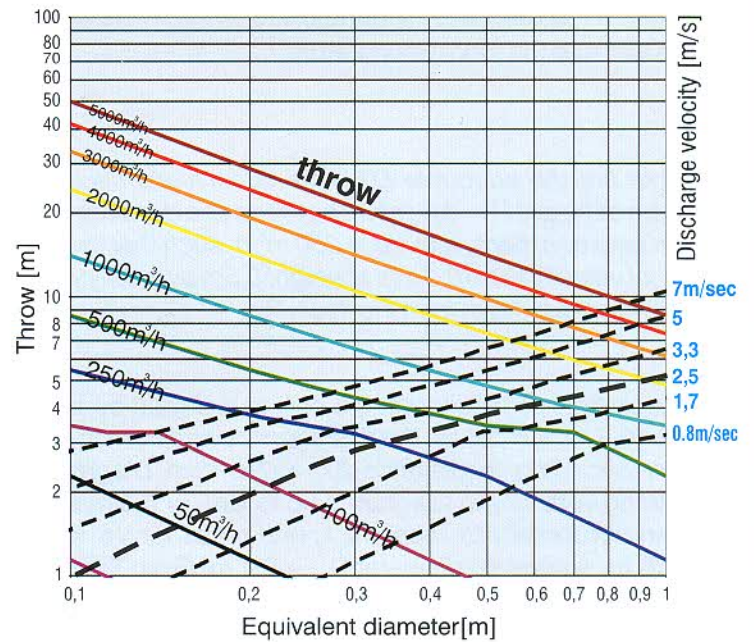
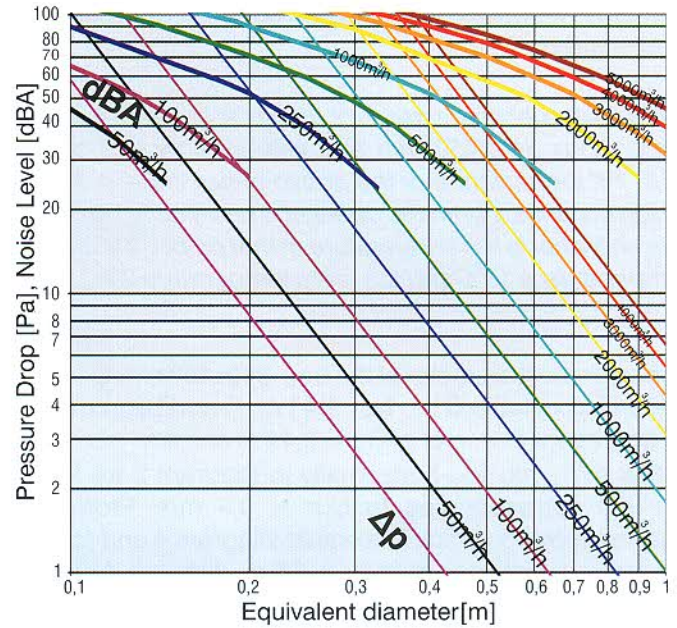

TABLE O4 : EQUIVALENT DIAMETER OF O4 GRILLES (in cm) QUICK SELECTION

		H[cm]											
		15	23	30	38	45	53	60	70	80	90	100	110
W[cm]	15	17	21	24	27	29	32	34	37				
	23	21	26	30	33	36	39	42	45	48	51		
	30	24	30	34	38	41	45	48	52	55	59	62	65
	38	27	33	38	43	47	51	54	58	62	66	70	73
	45	29	36	41	47	51	55	59	63	68	72	76	79
	53	32	39	45	51	55	60	64	69	73	78	82	86
	60	34	42	48	54	59	64	68	73	78	83	87	92
	70	37	45	52	58	63	69	73	79	84	90	94	99
	80		48	55	62	68	73	78	84	90	96	101	106
	90		51	59	66	72	78	83	90	96	102	107	112
	100			62	70	76	82	87	94	101	107	113	118
110			65	73	79	86	92	99	106	112	118	124	

Due to continuous development of its products, AERGRAMMI reserves the right of modifications without prior notice.

Selection example - detailed calculation of air jet characteristics

What are the jet characteristics using O1 grilles of nominal dimensions 300X450 mm and with air flow rate of 250 m³/h ? If the distance of the above grilles is 2X = 5m, at which distance Y from the ceiling the air velocity Um = 0,3 m/s and what is the temperature at that point if the air inlet temperature is 15°C and the room temperature 25°C?

The equivalent diameter of the Deq 300x450 mm O1 grille is found from table O1 to be 0,41 m. From Diagram 1 for an equivalent diameter of D_{eq} = 0,41 m and flow rate of Vo = 250 m³/h, moving horizontally to Diagram 2 we reach the line corresponding to Um = 0,3 m/s. From this position moving vertically towards Diagram 4 and for half the distance between grilles, i.e. 2,5 m, distance Y = 1,4m is found. From Diagram 5 for D_{eq} = 0,41 m and Vo = 250 m³/h, moving horizontally to Diagram 6 and for distance 7,1 m, ΔT_q is calculated around 0,015. Thus, T_m is almost the same as the room temperature.

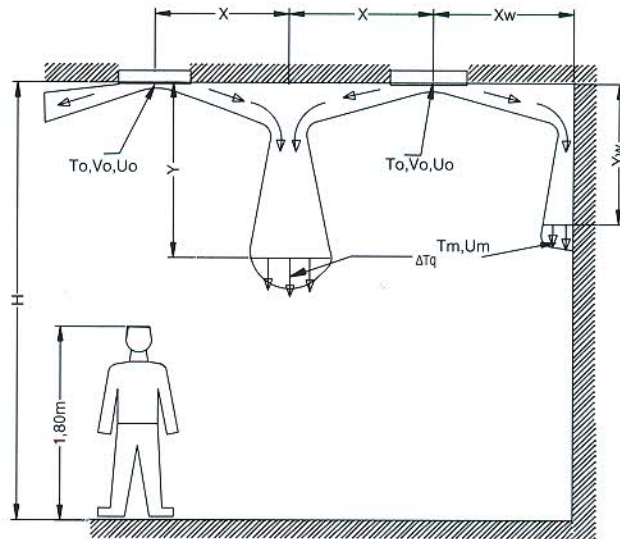

HEIGHT CONVERSION COEFFICIENT Y
for wall impinging jet : Yw = 0.532 Y

What are the adequate O1 grille dimensions serving a room of height H = 3,8 m while placed at a distance 2X = 7m between them, with Vo = 250 m³/h, such that the final air jet velocity to be 0,3 m/s at height 0,5m over the people moving area - 1,8 m from the floor - ?

The vertical distance from the ceiling Y should be under 3,8 - 0,5 - 1,8 = 1,5 m. For this distance and from the line corresponding to distance 2X = 7m from Diagram 4, moving vertically to Diagram 2 up to Um = 0,3 m/s and then horizontally to Diagram 1, one reads for Vo = 250 m³/h an equivalent diameter D_{eq} = 0,4 m. From Table O1 and for this diameter it is found that the grille should be of dimensions 300X300mm or 600X150mm or even 230X380mm (D_{eq} = 0,33 m).

TABLE O1 : EQUIVALENT DIAMETER OF O1 GRILLES

H[cm]

	15	23	30	38	45	53	60	70	80	90	100	110
15	17	21	24	27	29	32	34	37				
23	21	26	30	33	36	39	42	45	48	51		
30	24	30	34	38	41	45	48	52	55	59	62	65
38	27	33	38	43	47	51	54	58	62	66	70	73
45	29	36	41	47	51	55	59	63	68	72	76	79
53	32	39	45	51	55	60	64	69	73	78	82	86
60	34	42	48	54	59	64	68	73	78	83	87	92
70	37	45	52	58	63	69	73	79	84	90	94	99
80		48	55	62	68	73	78	84	90	96	101	106
90		51	59	66	72	78	83	90	96	102	107	112
100			62	70	76	82	87	94	101	107	113	118
110			65	73	79	86	92	99	106	112	118	124

W[cm]

Due to continuous development of its products, AERGRAMMI reserves the right of modifications without prior notice.

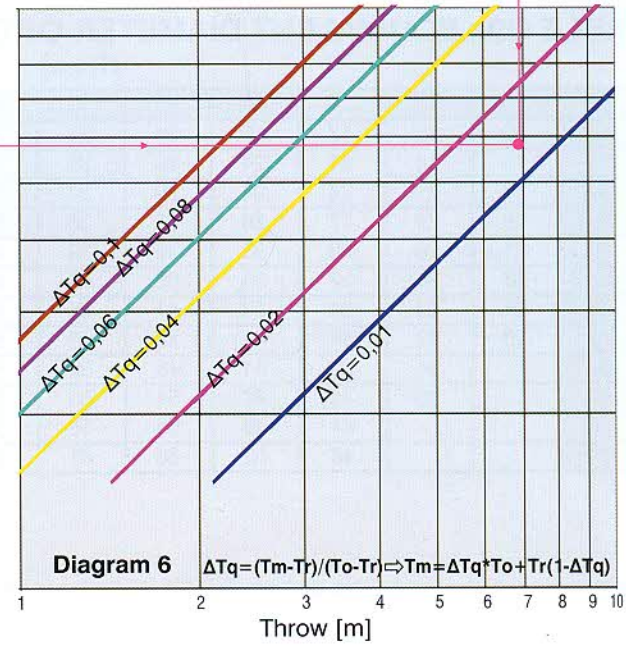
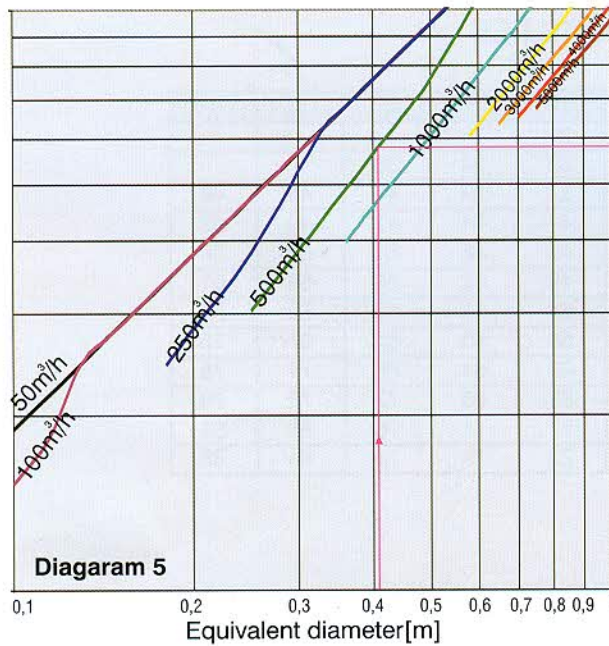
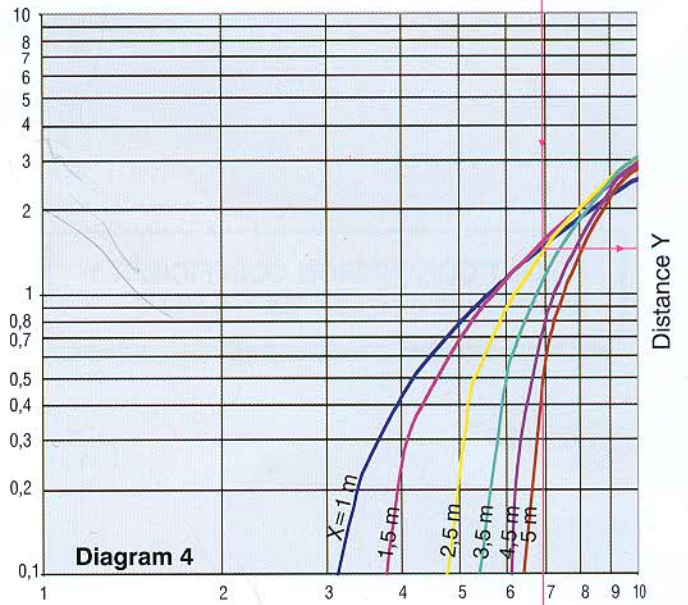
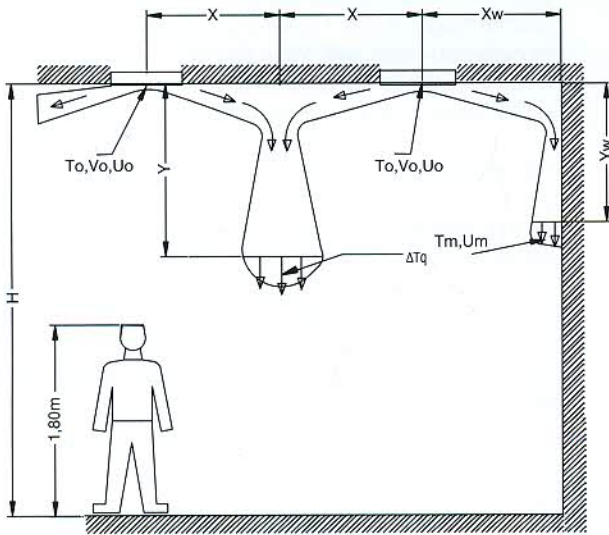
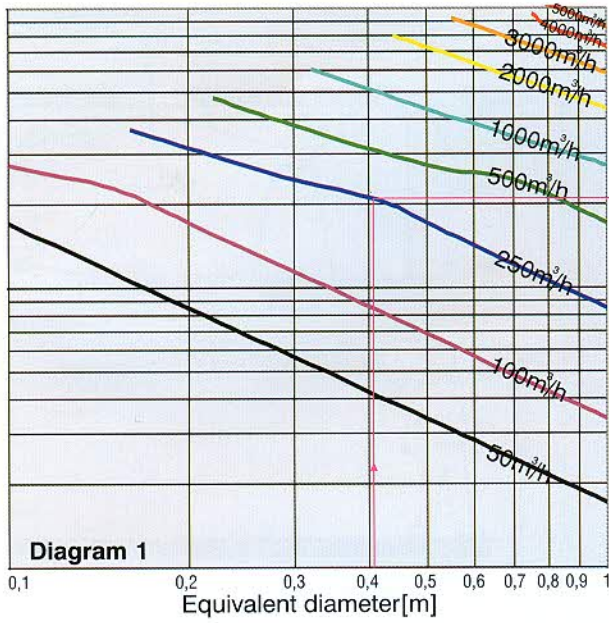

Selection example - detailed calculation of air jet characteristics

What are the jet characteristics using O2 grilles of nominal dimensions 450x450 mm with air volume flow rate of 500 m³/h ? What is the required distance between two of these grilles so that the final air velocity would be $U_m = 0,3$ m/s at distance $Y = 0,9$ m from the ceiling and what is the temperature at this point if the air inlet temperature is 25°C and the room temperature 35°C?

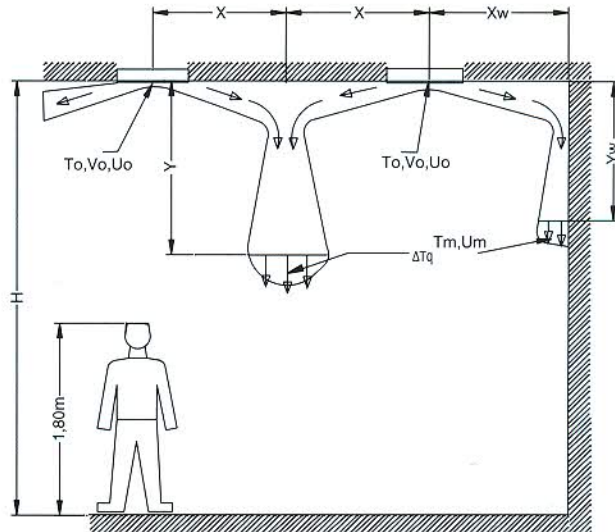

For the detailed calculation the equivalent diameter at each direction of the flow is used. The equivalent diameter of the 450x450 mm O2 grille is found from table O2 to be $D_{eq} \approx 0,36$ m. From Diagram 1 for an equivalent diameter of $D_{eq} = 0,36$ m and flow rate of $V_o = 250$ m³/h, moving horizontally to Diagram 2 we reach the line corresponding to $U_m = 0,3$ m/s. From this position moving vertically towards Diagram 4 one finds $2X = 7,2$ m for distance $Y = 0,9$ m. From Diagram 5 for $D_{eq} = 0,36$ m and $V_o = 250$ m³/h, moving horizontally to Diagram 6 and for distance 7,2 m, ΔT_q is calculated around 0,015. Thus, T_m is almost the same as the mean room temperature.

What are the adequate O2 grille dimensions serving a room of height $H = 4,1$ m while placed at a distance $2X = 3$ m between them, with $V_o = 250$ m³/h, such that the final air jet velocity to be 0,15 m/s at height 0,3m over the people moving area - 1,8 m from the floor - ?

The vertical distance from the ceiling Y should be under $4,1 - 0,3 - 1,8 \approx 2$ m. For this distance and from the line corresponding to distance $2X = 3$ m ($X = 1,5$ m) from Diagram 4, moving vertically to Diagram 2 up to $U_m = 0,15$ m/s and then horizontally to Diagram 1, one reads for $V_o = 125$ m³/h (half of the total) an equivalent diameter $D_{eq} = 0,46$ m. From Table O2 and for this diameter it is found that the grille should be of dimensions 530x600mm.

HEIGHT CONVERSION COEFFICIENT Y
for wall impinging jet : $Y_w = 0.532 Y$

TABLE O2 : EQUIVALENT DIAMETER OF O2 GRILLES

H[cm]

	15	23	30	38	45	53	60	70	80	90	100	110
15	12	15	17	19	21	23	24	26				
23	15	18	21	24	26	28	30	32	34	36		
30	17	21	24	27	29	32	34	37	39	41	44	46
38	19	24	27	30	33	36	38	41	44	47	49	52
45	21	26	29	33	36	39	41	45	48	51	54	56
53	23	28	32	36	39	42	45	49	52	55	58	61
60	24	30	34	38	41	45	48	52	55	59	62	65
70	26	32	37	41	45	49	52	56	60	63	67	70
80		34	39	44	48	52	55	60	64	68	71	75
90		36	41	47	51	55	59	63	68	72	76	79
100			44	49	54	58	62	67	71	76	80	84
110			46	52	56	61	65	70	75	79	84	88

Due to continuous development of its products, AERGRAMMI reserves the right of modifications without prior notice.

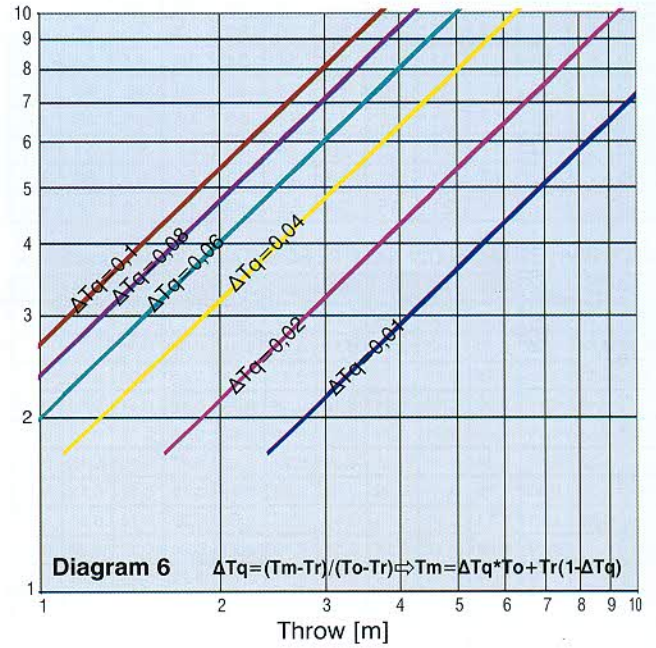
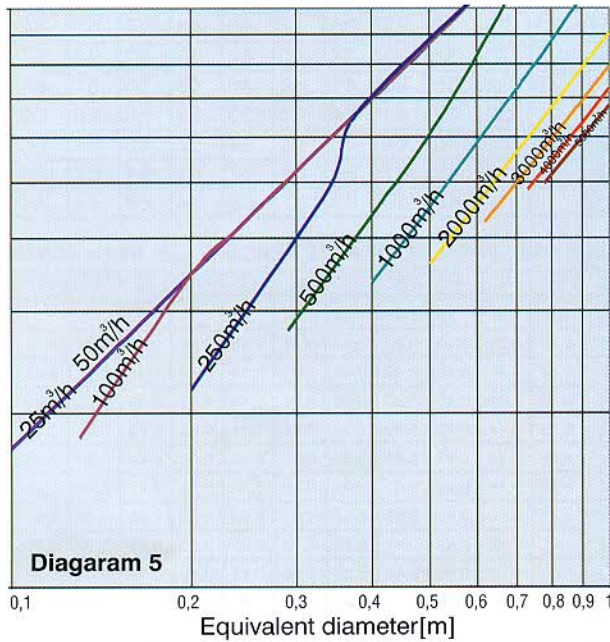
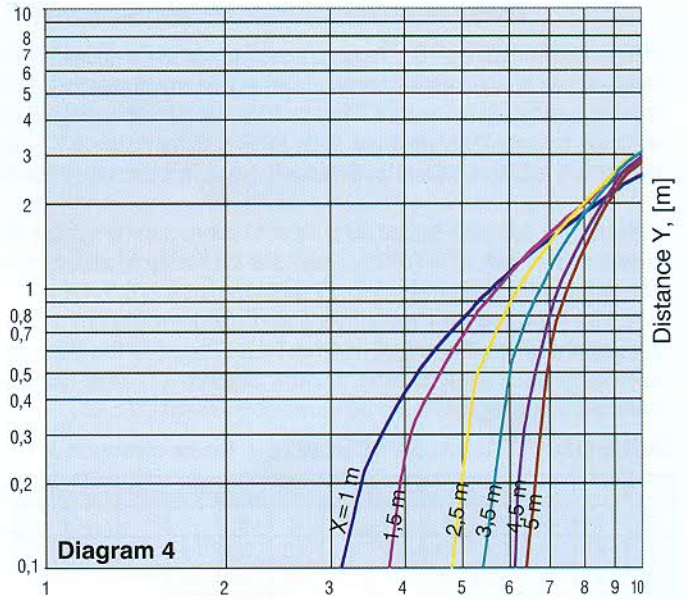
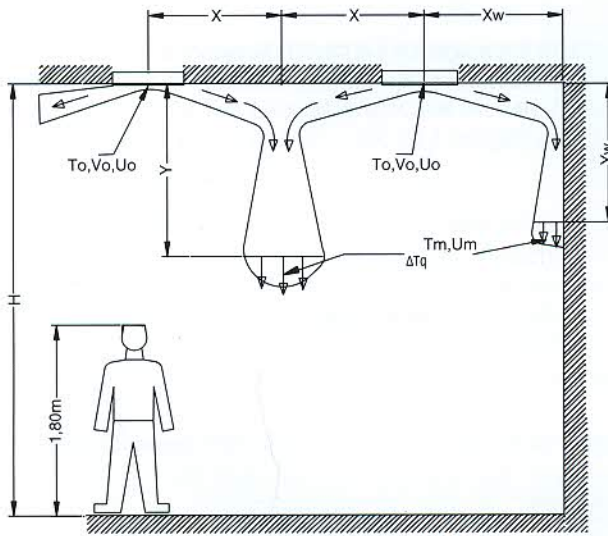
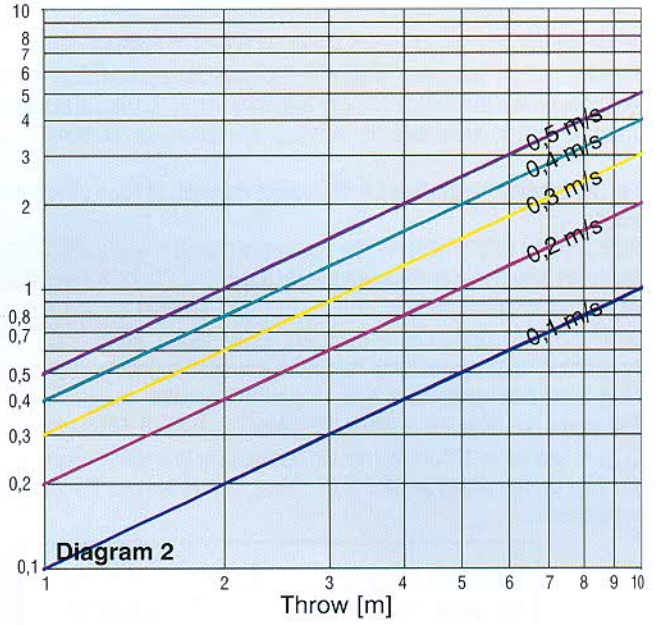
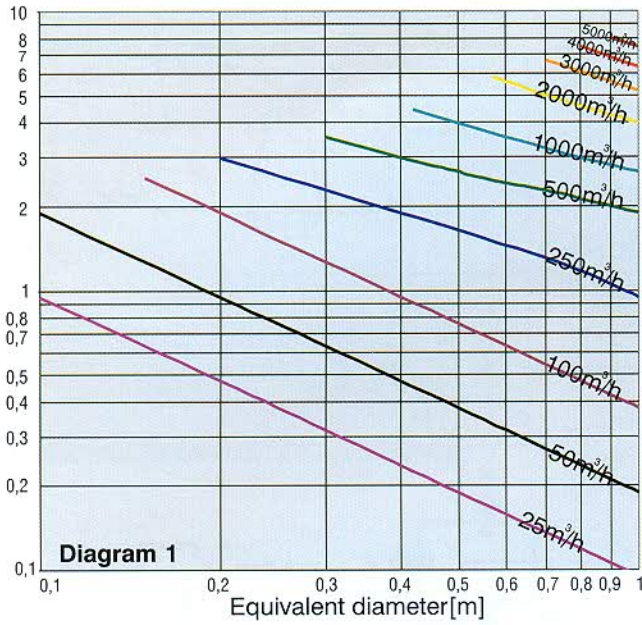

Selection example - detailed calculation of air jet characteristics

What are the jet characteristics using O3 grilles of nominal dimensions 450x450 mm and with air flow rate of 500 m³/h ? What is the required distance between these grilles such that the final air velocity would be $U_m = 0,3$ m/s at distance $Y = 0,85$ m from the ceiling, and what is the temperature ratio at that position?

For the detailed calculation the equivalent diameter at each direction of the flow is used.

FOR THROW DIRECTION A : The equivalent diameter of the 450x450 mm O3 grille for throw direction A is found from table O3a to be $\approx 0,25$ m. From Diagram 1 for an equivalent diameter of $Deq = 0,25$ m (from Table O3a) and flow rate of $Vo = 500 \cdot 0,25 = 125$ m³/h (coefficient 0,25 found from Table O3c), moving horizontally to Diagram 2 we reach the line corresponding to $U_m = 0,3$ m/s and read horizontal distance 5,4 m. From this position moving vertically towards Diagram 4 one finds $2X = 3$ m for distance $Y = 0,85$ m. From Diagram 5 for $Deq = 0,25$ m and $Vo = 125$ m³/h, moving horizontally to Diagram 6 and for distance 5,4 m, ΔTq is calculated around 0,01. Thus, T_m is almost the same as the room temperature.

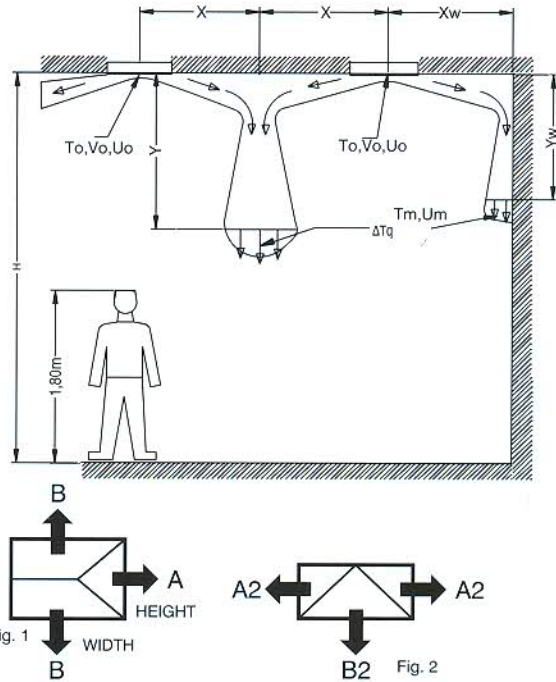

HEIGHT CONVERSION COEFFICIENT Y
for wall impinging jet : $Y_w = 0.532 Y$

FOR THROW DIRECTION B : The equivalent diameter of the 450x450 mm O3 grille for throw direction B is found from table O3b to be 0,31 m. From Diagram 1 for an equivalent diameter of $Deq = 0,31$ m and volume flow rate of $Vo = 500 \cdot 0,38 = 190$ m³/h (coefficient 0,38 found from Table O3d), moving horizontally to Diagram 2 we reach the line corresponding to $U_m = 0,3$ m/s and read horizontal distance 6,2 m. From this position moving vertically towards Diagram 4 one finds $2X = 5$ m for distance $Y = 0,85$ m. From Diagram 5 for $Deq = 0,31$ m and $Vo = 190$ m³/h, moving horizontally to Diagram 6 and for distance 6,2 m, ΔTq is calculated less than 0,01.

What are the adequate square O3 grille dimensions serving a room of height $H = 3$ m while placed at a distance $2X = 3$ m (throw direction B) between them, with $Vo = 100$ m³/h, such that the final air jet velocity to be 0,2 m/s at height 0,5 m over the people moving area - 1,8 m from the floor- The vertical distance from the ceiling Y should be under $3 - 0,5 - 1,8 = 0,7$ m. For this distance and from curve corresponding to distance $2X = 3$ m ($X = 1,5$ m) from Diagram 4, moving vertically to Diagram 2 up to $U_m = 0,2$ m/s and then horizontally to Diagram 1, one reads for $Vo = 100$ m³/h an equivalent diameter $Deq = 0,38$ m. From Table O3b and for this diameter it is found that the grille should be of dimensions 530x530mm.

In case the had a shape as in fig. 2, throw direction A2 has an equivalent diameter of $A2 = 1,4XA$, while $B2 = B$ and air flow is divided to 25% towards throw direction A2 and 50% towards throw direction B2.

TABLE O3a : EQUIVALENT DIAMETER throw direction A

	15	23	30	38	45	53	60	70	80	90	100	110
15	8	8	8	8	8	8	8	8				
23	8	13	13	13	13	13	13	13	13			
30	8	13	17	17	17	17	17	17	17	17		
38	8	13	17	21	21	21	21	21	21	21	21	
45	8	13	17	21	25	25	25	25	25	25	25	25
53	8	13	17	21	25	30	30	30	30	30	30	30
60	8	13	17	21	25	30	34	34	34	34	34	34
70	8	13	17	21	25	30	34	40	40	40	40	40
80		13	17	21	25	30	34	40	45	45	45	45
90		13	17	21	25	30	34	40	45	51	51	51
100			17	21	25	30	34	40	45	51	56	56
110			17	21	25	30	34	40	45	51	56	62

TABLE O3b : EQUIVALENT DIAMETER throw direction B

	15	23	30	38	45	53	60	70	80	90	100	110
15	10	14	16	18	20	22	23	25				
23	14	16	19	22	24	26	28	31	33	35		
30	16	19	21	24	27	29	32	35	37	40	42	44
38	18	22	24	26	29	32	35	38	41	44	47	49
45	20	24	27	29	31	35	37	41	44	48	50	53
53	22	26	29	32	35	37	40	44	47	51	54	57
60	23	28	32	35	37	40	41	46	50	54	57	60
70	25	31	35	38	41	44	46	48	53	57	61	64
80		33	37	41	44	47	50	53	55	60	64	68
90		35	40	44	48	51	54	57	60	62	67	71
100			42	47	50	54	57	61	64	67	69	74
110			44	49	53	57	60	64	68	71	74	76

TABLE O3c : TOTAL FLOW RATE PERCENTAGE throw direction A

	15	23	30	38	45	53	60	70	80	90	100	110
15	0,25	0,16	0,13	0,10	0,08	0,07	0,06	0,05				
23	0,16	0,25	0,19	0,15	0,13	0,11	0,10	0,08	0,07	0,06		
30	0,13	0,19	0,25	0,20	0,17	0,14	0,13	0,11	0,09	0,08	0,08	0,07
38	0,10	0,15	0,20	0,25	0,21	0,18	0,16	0,14	0,12	0,11	0,10	0,09
45	0,08	0,13	0,17	0,21	0,25	0,21	0,19	0,16	0,14	0,13	0,11	0,10
53	0,07	0,11	0,14	0,18	0,21	0,25	0,22	0,19	0,17	0,15	0,13	0,12
60	0,06	0,10	0,13	0,16	0,19	0,22	0,25	0,21	0,19	0,17	0,15	0,14
70	0,05	0,08	0,11	0,14	0,16	0,19	0,21	0,25	0,22	0,19	0,18	0,16
80		0,07	0,09	0,12	0,14	0,17	0,19	0,22	0,25	0,22	0,20	0,18
90		0,06	0,08	0,11	0,13	0,15	0,17	0,19	0,22	0,25	0,23	0,20
100			0,08	0,10	0,11	0,13	0,15	0,18	0,20	0,23	0,25	0,23
110			0,07	0,09	0,10	0,12	0,14	0,16	0,18	0,20	0,23	0,25

TABLE O3d : TOTAL FLOW RATE PERCENTAGE throw direction B

	15	23	30	38	45	53	60	70	80	90	100	110
15	0,38	0,42	0,44	0,45	0,46	0,46	0,47	0,47				
23	0,42	0,38	0,40	0,42	0,44	0,45	0,45	0,46	0,46	0,47		
30	0,44	0,40	0,38	0,40	0,42	0,43	0,44	0,45	0,45	0,46	0,46	0,47
38	0,45	0,42	0,40	0,38	0,39	0,41	0,42	0,43	0,44	0,45	0,45	0,46
45	0,46	0,44	0,42	0,39	0,38	0,39	0,41	0,42	0,43	0,44	0,44	0,45
53	0,46	0,45	0,43	0,41	0,39	0,38	0,39	0,41	0,42	0,43	0,43	0,44
60	0,47	0,45	0,44	0,42	0,41	0,39	0,38	0,39	0,41	0,42	0,43	0,43
70	0,47	0,46	0,45	0,43	0,42	0,41	0,39	0,38	0,39	0,40	0,41	0,42
80		0,46	0,45	0,44	0,43	0,42	0,41	0,39	0,38	0,39	0,40	0,41
90		0,47	0,46	0,45	0,44	0,43	0,42	0,40	0,39	0,38	0,39	0,40
100			0,46	0,45	0,44	0,43	0,43	0,41	0,40	0,39	0,38	0,39
110			0,47	0,46	0,45	0,44	0,43	0,42	0,41	0,40	0,39	0,38

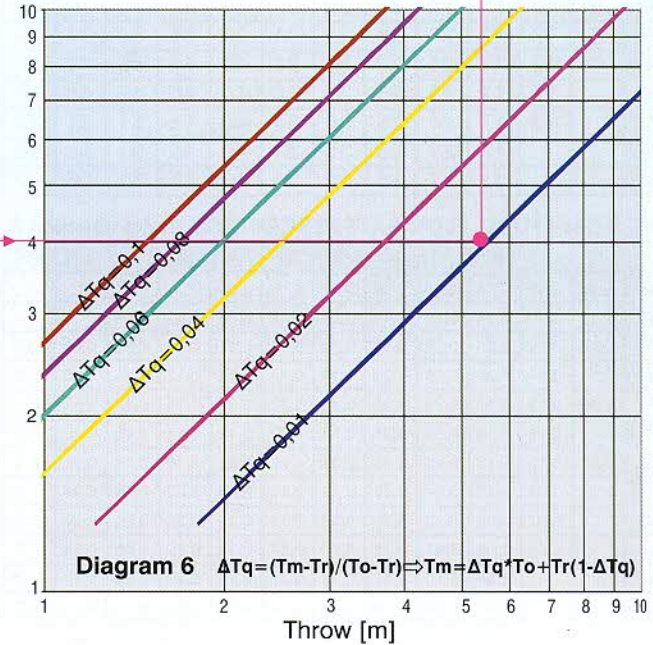
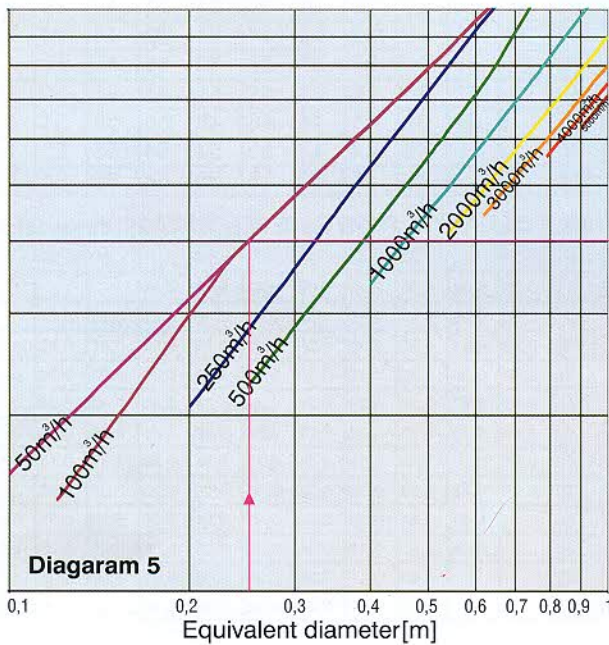
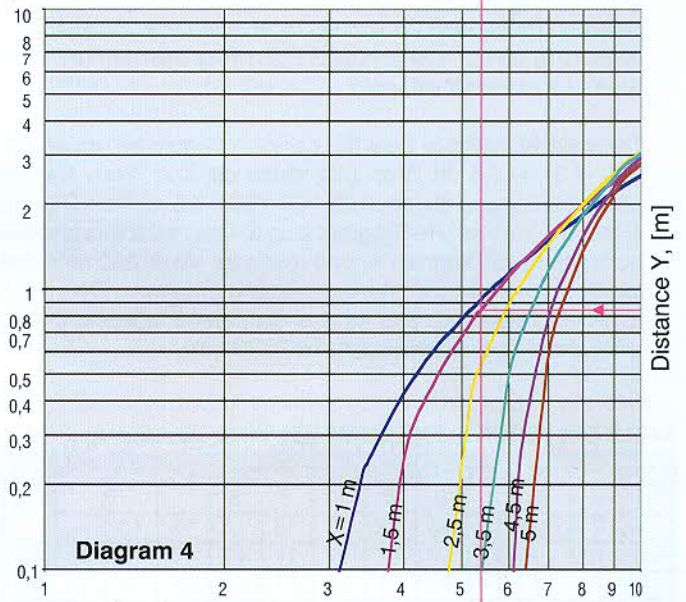
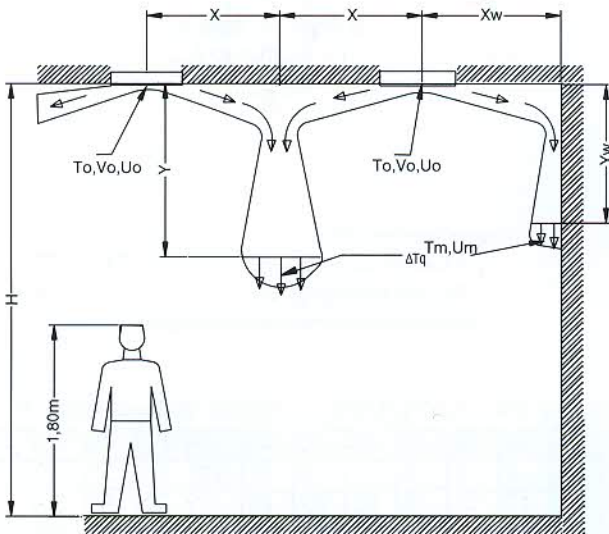
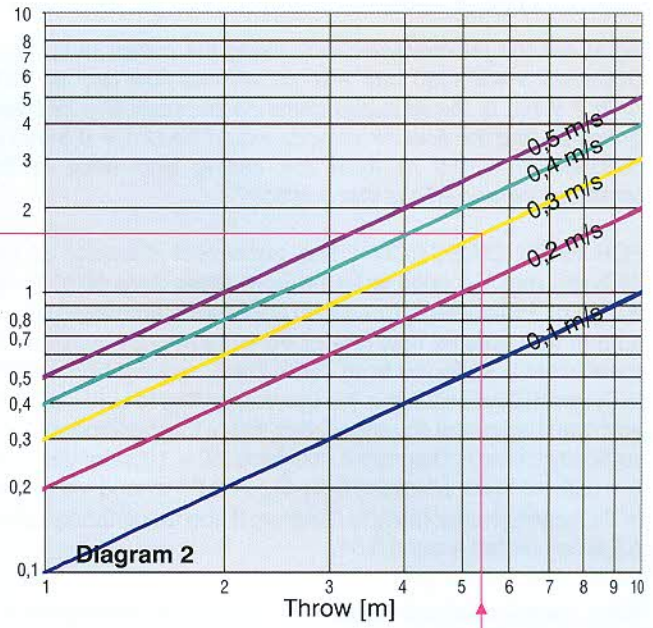
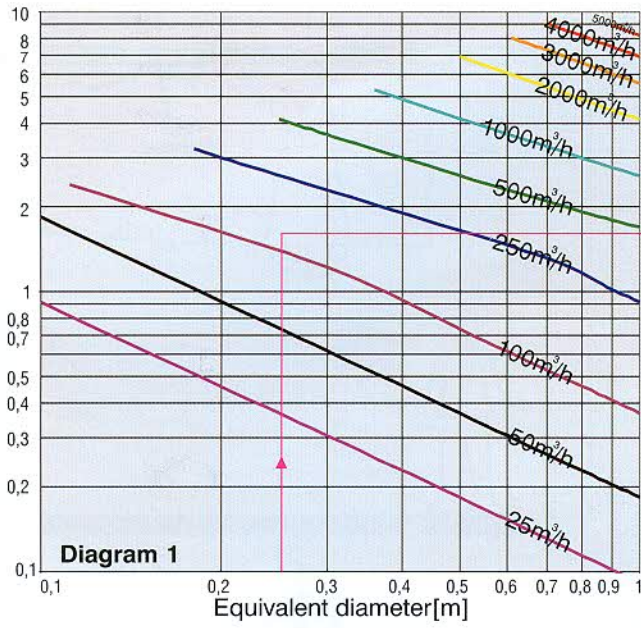

Selection example - detailed calculation of air jet characteristics

What are the jet characteristics using O4 grilles of nominal dimensions 450X450 mm with air volume flow rate of 1000 m³/h ? What is the required distance between two of these grilles so that the final air velocity would be $U_m = 0,3$ m/s at distance $Y = 0,9$ m from the ceiling and what is the temperature ratio ΔT_q at that position?

FOR EACH DIRECTION : The equivalent diameter of the 450x450 mm O4 grille is found from table O4(a or b) to be $\approx 0,25$ m. From Diagram 1 for an equivalent diameter of $D_{eq} = 0,25$ m and volume flow rate of $V_o = 1000 \cdot 0,25 = 250$ m³/h (coefficient 0,25 found from Table O4c), moving horizontally to Diagram 2 we reach the line corresponding to $U_m = 0,3$ m/s and read horizontal distance 7,3 m. From this position moving vertically towards Diagram 4 one finds $2X = 10$ m for distance $Y = 0,9$ m. From Diagram 5 for $D_{eq} = 0,25$ m and $V_o = 250$ m³/h, moving horizontally to Diagram 6 and for distance 7,3 m, ΔT_q is calculated around 0,01.

What are the adequate square O4 grille dimensions serving a room of height $H = 3,5$ m while placed at a distance $2X = 7$ m between them, with $V_o = 1000$ m³/h, such that the final air jet velocity to be 0,3 m/s at height 0,2m over the people moving area - 1,8 m from the floor - ?

The vertical distance from the ceiling Y should be under $3,5 - 0,2 - 1,8 = 1,5$ m. For this distance and from the line corresponding to distance $2X = 7$ m ($X = 3,5$ m) from Diagram 4, moving vertically to Diagram 2 up to $U_m = 0,2$ m/s and then horizontally to Diagram 1, one reads for $V_o = 250$ m³/h (one fourth of the total flow rate) an equivalent diameter $D_{eq} = 0,51$ m. From Table O4a and for this diameter it is found that the grille should be of dimensions 900X900mm.

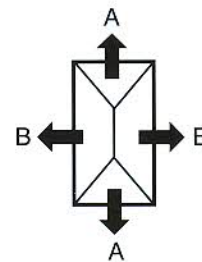
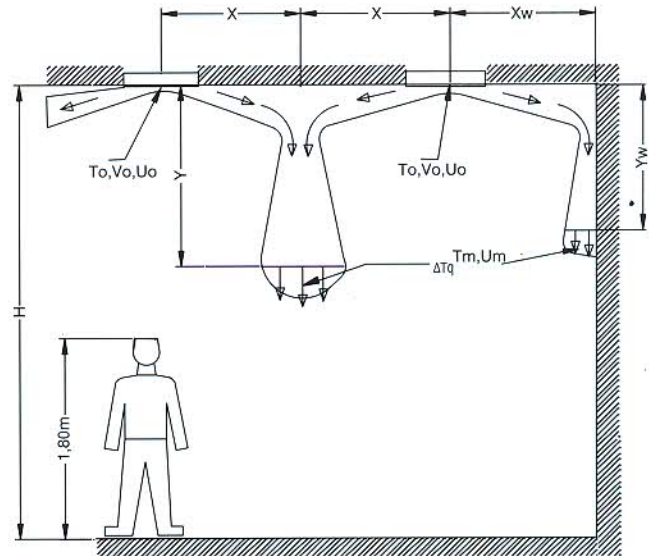

HEIGHT CONVERSION COEFFICIENT Y for wall impinging jet : $Y_w = 0.532 Y$

TABLE O4a : EQUIVALENT DIAMETER throw direction A

	15	23	30	38	45	53	60	70	80	90	100	110
15	8	8	8	8	8	8	8	8				
23	8	13	13	13	13	13	13	13	13			
30	8	13	17	17	17	17	17	17	17	17		
38	8	13	17	21	21	21	21	21	21	21	21	
45	8	13	17	21	25	25	25	25	25	25	25	
53	8	13	17	21	25	30	30	30	30	30	30	
60	8	13	17	21	25	30	34	34	34	34	34	
70	8	13	17	21	25	30	34	40	40	40	40	
80		13	17	21	25	30	34	40	45	45	45	
90		13	17	21	25	30	34	40	45	51	51	
100			17	21	25	30	34	40	45	51	56	
110			17	21	25	30	34	40	45	51	56	62

TABLE O4b : EQUIVALENT DIAMETER throw direction B

	15	23	30	38	45	53	60	70	80	90	100	110
15	8	12	15	17	19	21	22	24				
23	12	13	16	20	22	25	27	29	32	34		
30	15	16	17	21	24	27	29	32	35	38	40	43
38	17	20	21	21	25	29	32	35	38	41	44	47
45	19	22	24	25	25	30	33	37	41	44	47	50
53	21	25	27	29	30	30	34	38	42	46	50	53
60	22	27	29	32	33	34	34	39	44	48	52	55
70	24	29	32	35	37	38	39	40	45	50	54	58
80		32	35	38	41	42	44	45	45	50	55	60
90		34	38	41	44	46	48	50	50	51	56	61
100			40	44	47	50	52	54	55	56	56	62
110			43	47	50	53	55	58	60	61	62	62

TABLE O4c : TOTAL FLOW RATE PERCENTAGE throw direction A

	15	23	30	38	45	53	60	70	80	90	100	110
15	0,25	0,16	0,13	0,10	0,08	0,07	0,06	0,05				
23	0,16	0,25	0,19	0,15	0,13	0,11	0,10	0,08	0,07	0,06		
30	0,13	0,19	0,25	0,20	0,17	0,14	0,13	0,11	0,09	0,08	0,08	0,07
38	0,10	0,15	0,20	0,25	0,21	0,18	0,16	0,14	0,12	0,11	0,10	0,09
45	0,08	0,13	0,17	0,21	0,25	0,21	0,19	0,16	0,14	0,13	0,11	0,10
53	0,07	0,11	0,14	0,18	0,21	0,25	0,22	0,19	0,17	0,15	0,13	0,12
60	0,06	0,10	0,13	0,16	0,19	0,22	0,25	0,21	0,19	0,17	0,15	0,14
70	0,05	0,08	0,11	0,14	0,16	0,19	0,21	0,25	0,22	0,19	0,18	0,16
80		0,07	0,09	0,12	0,14	0,17	0,19	0,22	0,25	0,22	0,20	0,18
90		0,06	0,08	0,11	0,13	0,15	0,17	0,19	0,22	0,25	0,23	0,20
100			0,08	0,10	0,11	0,13	0,15	0,18	0,20	0,23	0,25	0,23
110			0,07	0,09	0,10	0,12	0,14	0,16	0,18	0,20	0,23	0,25

TABLE O4d : TOTAL FLOW RATE PERCENTAGE throw direction B

	15	23	30	38	45	53	60	70	80	90	100	110
15	0,25	0,34	0,38	0,40	0,42	0,43	0,44	0,45				
23	0,34	0,25	0,31	0,35	0,37	0,39	0,40	0,42	0,43	0,44		
30	0,38	0,31	0,25	0,30	0,33	0,36	0,38	0,39	0,41	0,42	0,43	0,43
38	0,40	0,35	0,30	0,25	0,29	0,32	0,34	0,36	0,38	0,39	0,41	0,41
45	0,42	0,37	0,33	0,29	0,25	0,29	0,31	0,34	0,36	0,38	0,39	0,40
53	0,43	0,39	0,36	0,32	0,29	0,25	0,28	0,31	0,33	0,35	0,37	0,38
60	0,44	0,40	0,38	0,34	0,31	0,28	0,25	0,29	0,31	0,33	0,35	0,36
70	0,45	0,42	0,39	0,36	0,34	0,31	0,29	0,25	0,28	0,31	0,33	0,34
80		0,43	0,41	0,38	0,36	0,33	0,31	0,28	0,25	0,28	0,30	0,32
90		0,44	0,42	0,39	0,38	0,35	0,33	0,31	0,28	0,25	0,28	0,30
100			0,43	0,41	0,39	0,37	0,35	0,33	0,30	0,28	0,25	0,27
110			0,43	0,41	0,40	0,38	0,36	0,34	0,32	0,30	0,27	0,25

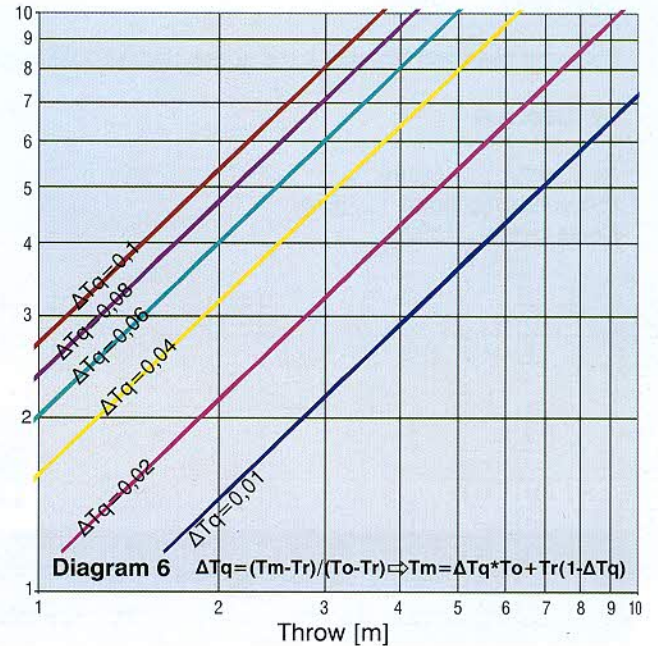
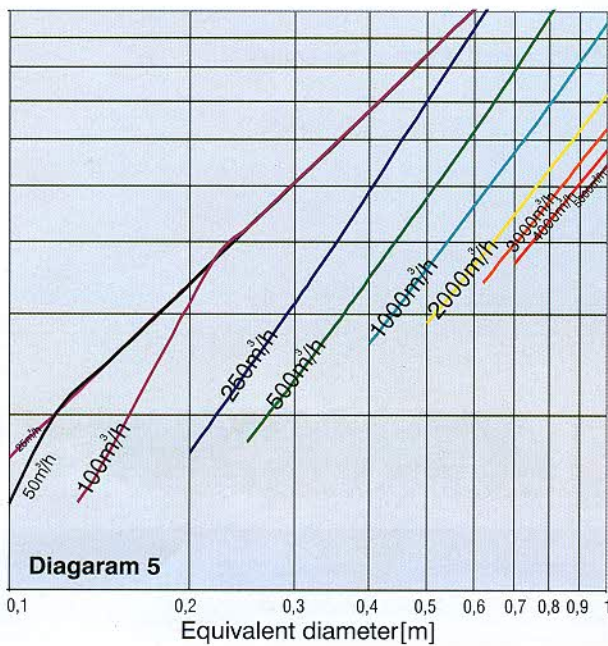
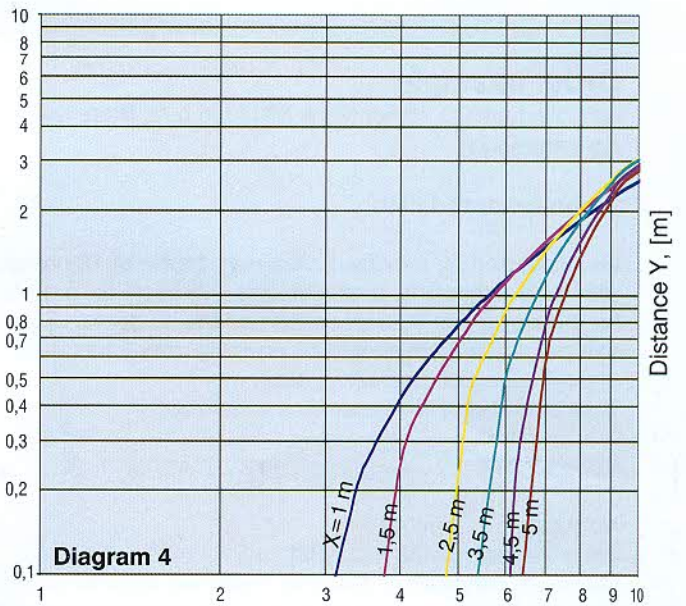
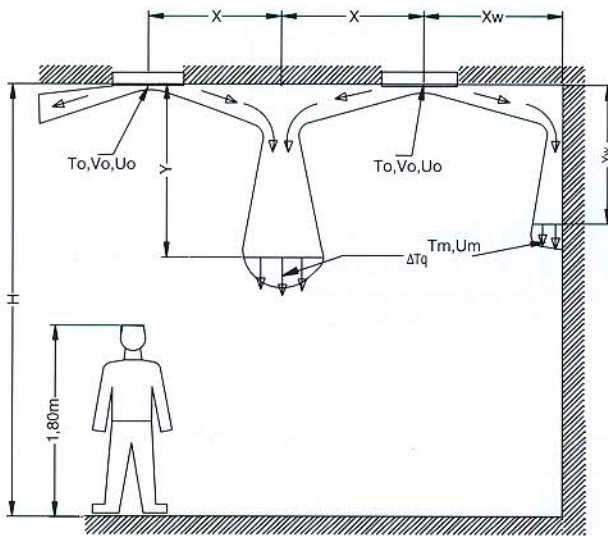
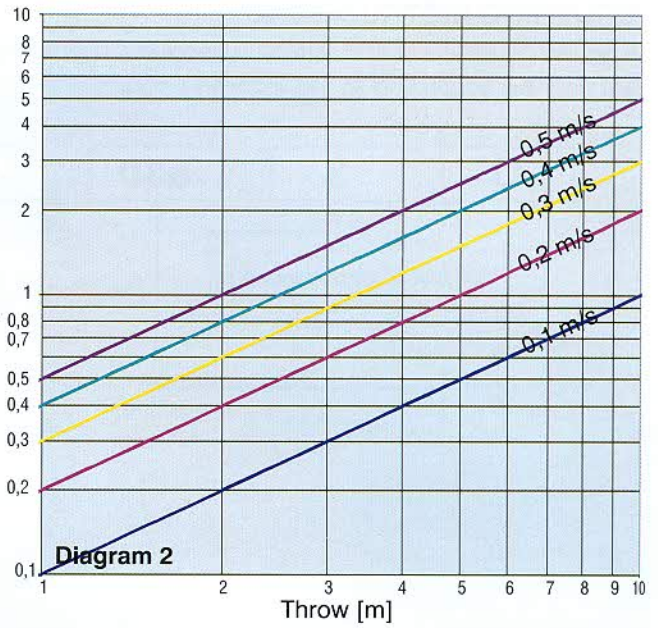
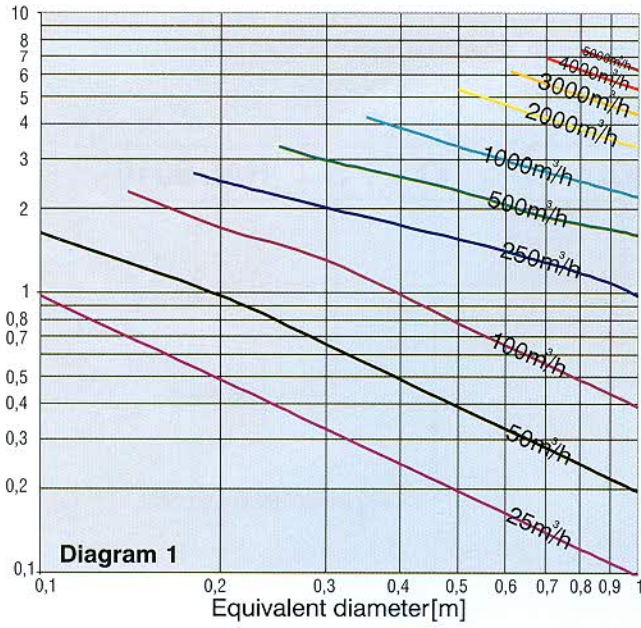

ORDERING INSTRUCTIONS

A series of numbers and letters is used in the ordering procedure. The characteristics of the air grille are defined according to the following code:

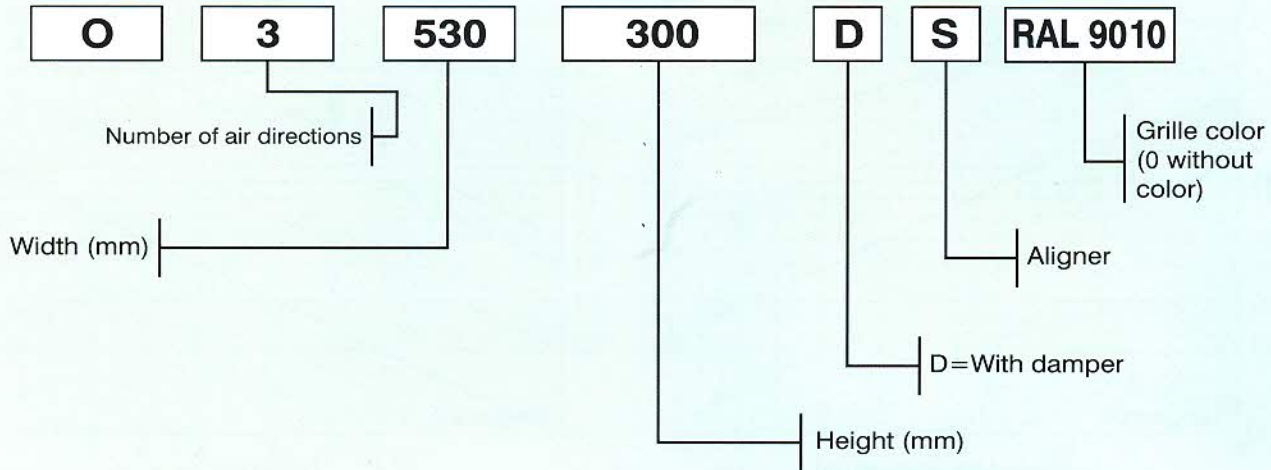

Order example

Air grille type O3, dimensions 530X300 mm, three ways jet stream with damper, no air flow distributor (aligner), no color :
O3 530X300 D

Technical description

Manufactured by anodized aluminum profile of 12 µm anodic depth (or electrostatically painted, RAL...) ceiling grilles with fixed orthogonal profile blades, adequate for providing air jet parallel to the ceiling. The blades should be removable for mounting with internal screws on the air ducts. Could be optionally accompanied with flow regulating dampers. The damper adjustment should be possible after it has been mounted without any further action, e.g. unmounting the grille or removing part of the ceiling, etc.

Their operational characteristics should be :

SUPPLY AIR

Air supply : [m³/h]
Pressure drop (total) : [Pa]
Maximum penetration distance Y with velocity $U_m = \dots$ m/s and overtemperature of supplied air ...°C : [m]
Distance between grilles for Y = ... [m] penetration of colliding jets : [m]
Noise level : ... [dBA]

For more than one directions the above data should be provided for each direction separately.

RETURN AIR

Air supply : [m³/h]
Pressure drop (total) : ... [Pa]
Noise level : ... [dBA]



End of Makrigianni street (over ring-road of Thessaloniki)
570 13 Thessaloniki - Tel: +30/2310 682.572 - Fax: +30/2310 685.047
www.aerogrammi.gr , e-mail:info@aerogrammi.gr